



OIL COOLER KIT INSTALLATION INSTRUCTIONS

PART NUMBER D570-0900

APPLICATION 2007-08 E90 335i/xi with stock oil cooler

Congratulations for being selective enough to use a Dinan Engineering Oil Cooler Kit. We have spent many hours developing this kit to assure that you will receive maximum performance and durability with minimum difficulty in installation. Please take the time to read these instructions and call us if you have any questions during the installation.

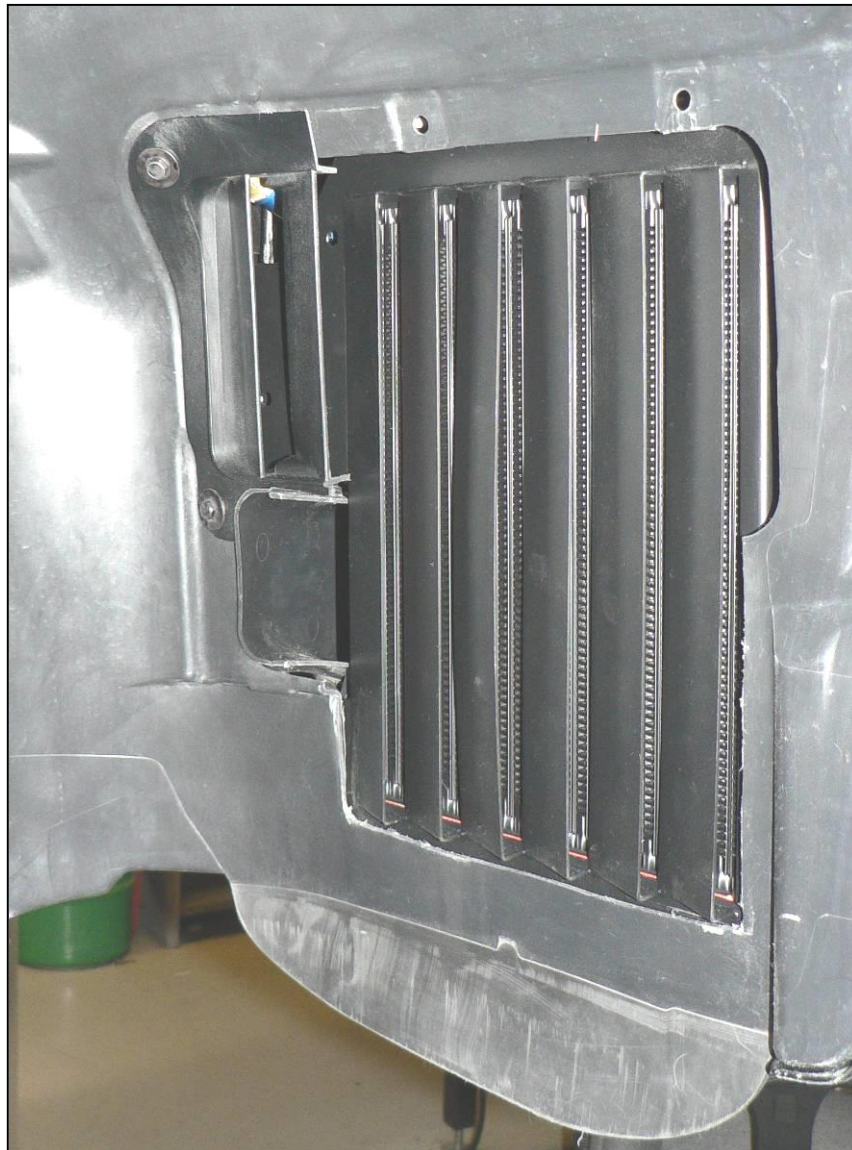

Important Note: Check for correct Fog Light

BMW has two different styles of fog lights installed on the stock cars. Only one will clear the larger Dinan oil cooler. Look at the right side fog light. If it has writing on the top of the lens as shown in figure 1, you have the correct shorter fog light. If it has no writing on it, you will need to order a new fog light (BMW # 63 17 7 158 542). Call Dinan as we have them in stock.

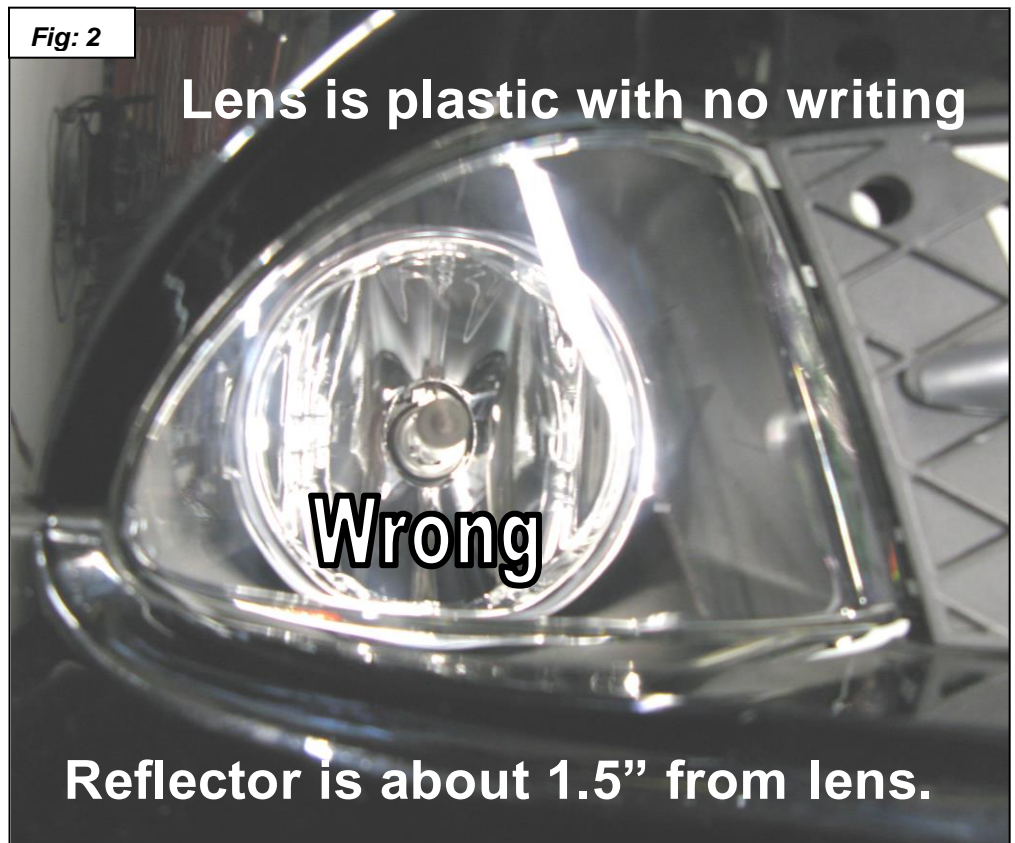
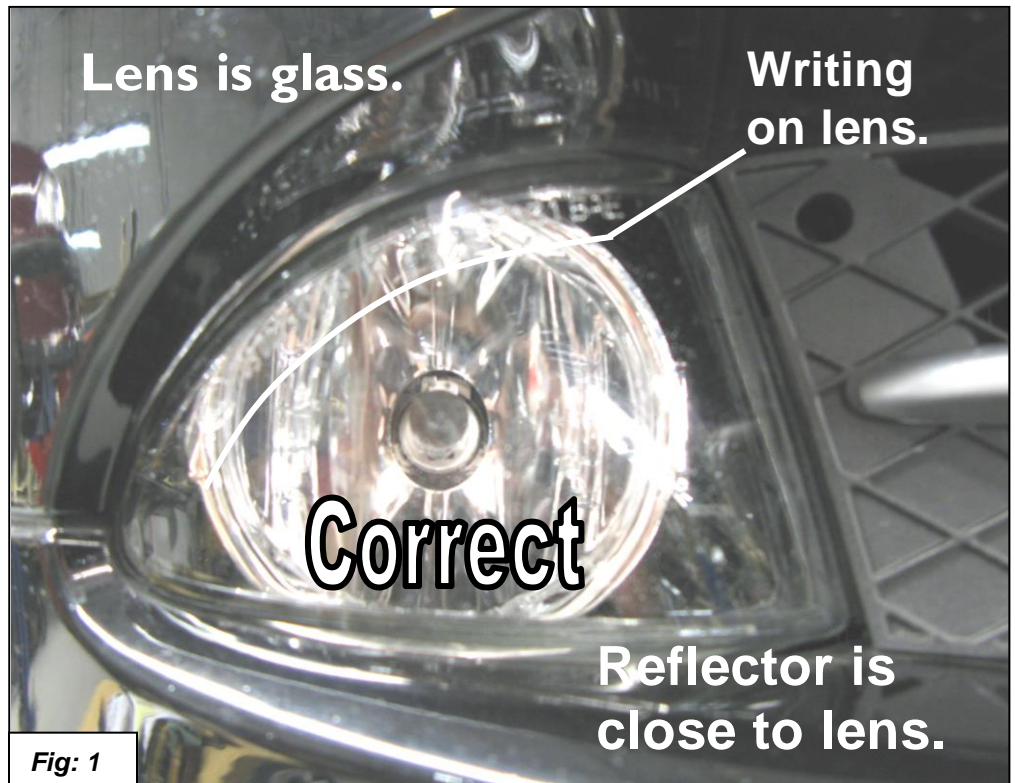

Important Note: All Cars

This kit is designed for cars with a standard bumper. This kit will not fit cars equipped with alternate bumpers, including the BMW M-Technic bumper.

Important Note: Cars with ACC (automatic cruise control)

Cars equipped with automatic cruise control require extra care when installing the Dinan oil cooler kit. When you loosen the radiator support assembly to install the new right side lower radiator mount / oil cooler mounts, mark the position of the nuts that hold it to the frame so you can install it in the same position. If you unplug the ACC sensor DO NOT turn the key ON, and make sure you plug it back in fully.

When the installation is complete, during your test drive check the operation of the ACC. If it does not function properly, you will have to adjust the sensor following BMW TIS instructions 66 31 001.

INSTALLATION INSTRUCTIONS

1. Lift car and secure with jack stands if needed.
2. Remove the right front wheel to get clearance to the oil cooler.
3. Remove the front bumper. Start by removing four Torx screws (1) from bumper trim (2) as shown in figure 1.

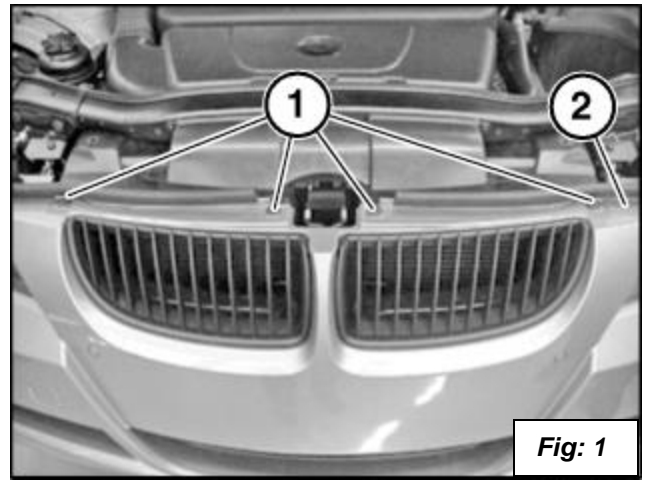

4. Remove the front inner fender on the right side by removing the screws at location (1) and (2). Unscrew the nut at location (3). Remove the Air Guide (4). Disconnect the connector from the tire pressure box. See figure 2.

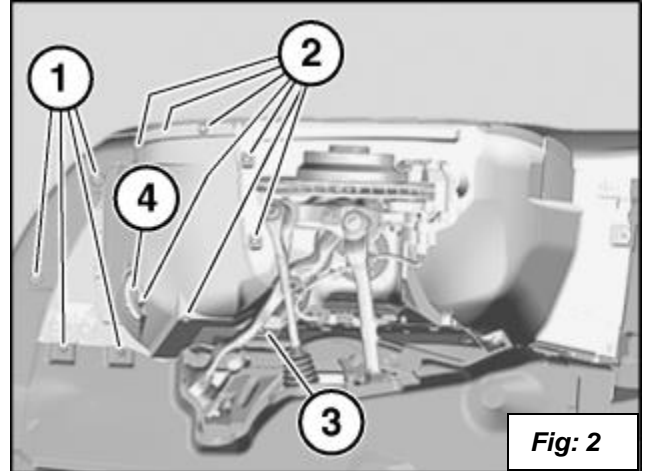

5. On the left side remove the screws in location (1) and pry out the inner fender (2) to gain access to the two screws you will remove in the next step. See figure 3.

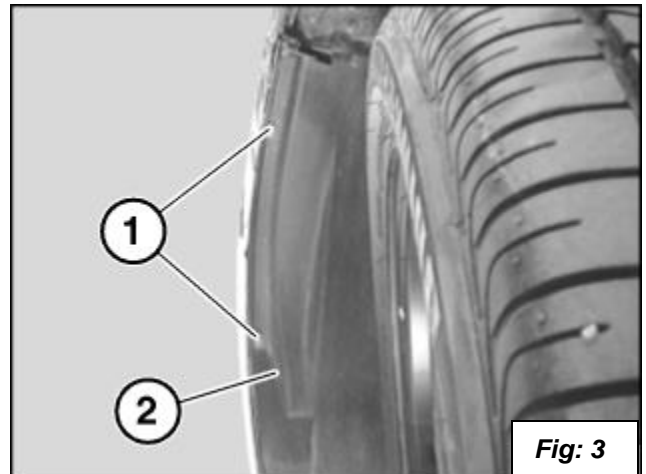

6. Pry the inner fender (1) out of the way and remove the two screws (2) holding the bumper to the fender. See figure 4.

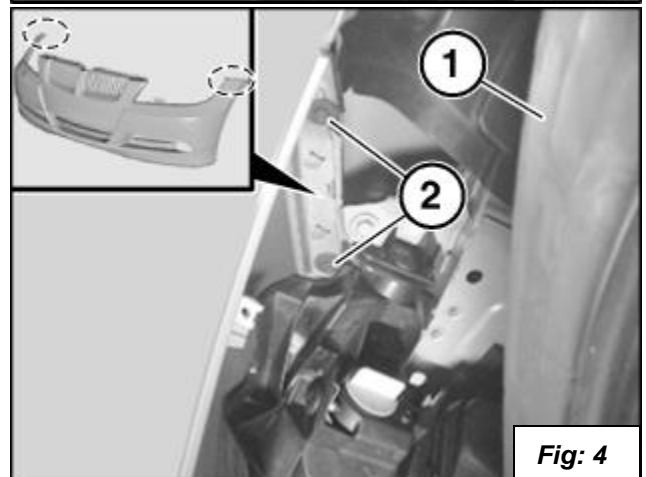

7. Disconnect the fog light connector and parking sensor connector if equipped with them.

8.

8. Remove the doors for the headlight cleaning system if your car is equipped with them. Pull out spray nozzle (1) by cover (2). Hold spray nozzle and carefully unclip cover sideways and remove. **Important! Do not let go of Spray Nozzle when removing Cover!** Grip spray nozzle firmly and slowly slide back into bumper after removing cover. Letting it slam back into bumper **will damage it!** See figure 5

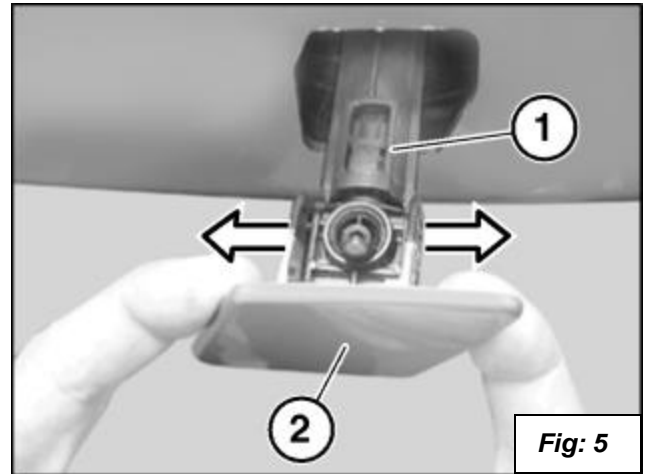

9. Remove the screws in location (1) from the bumper (2). See figure 6.
10. Prepare a safe place to put bumper after you remove it.

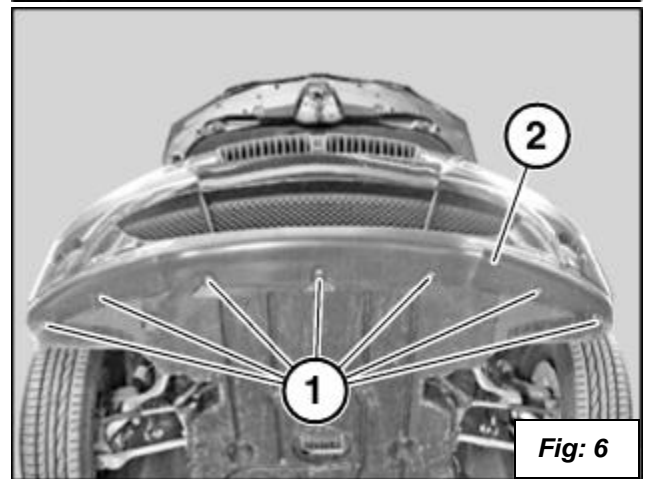

11. Remove bumper trim (1) with the aid of a second person by pulling out at top slightly and forward. See figure 7.

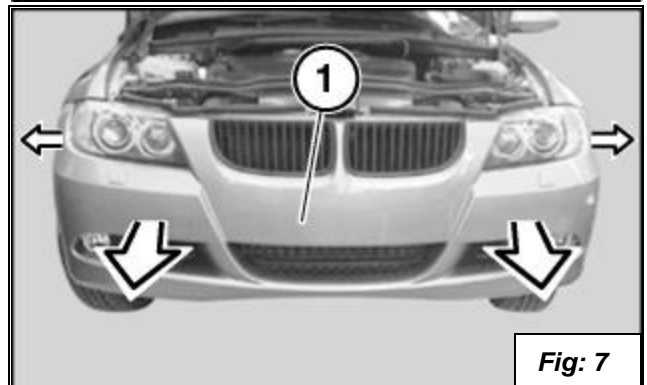

12. Remove the oil cooler. Start by putting a drain pan under the oil cooler where the lines attach. Remove the bolt holding the oil lines (1) to cooler. See figure 8.

- 13.

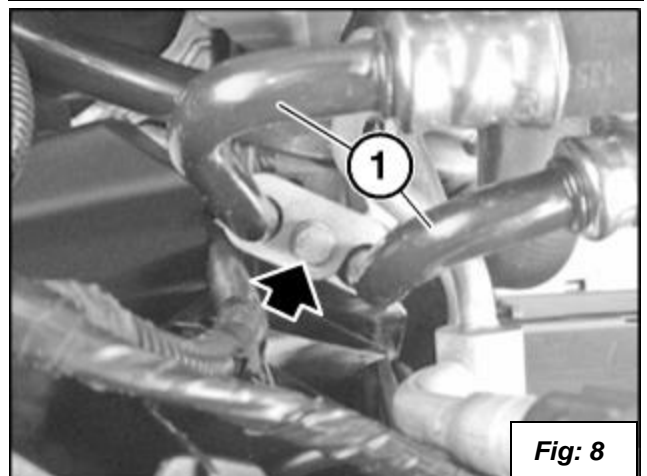

13. Remove the three screws marked with arrows that hold the duct to the oil cooler (3). See figure 9.
14. Remove the bolt (1) and the nuts (2) and save for installing on the new oil cooler. You will also need the rubber mounts and top bracket and will remove them in step 23. See figure 9.

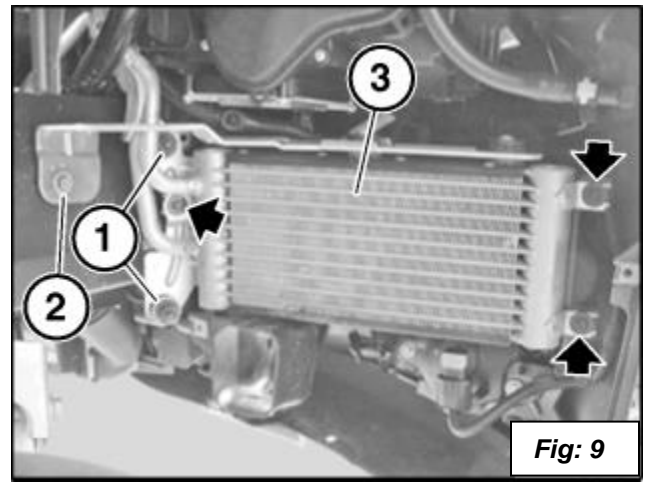

Fig: 9

15. Remove the air duct (1) that goes from the top of the radiator to the air box by removing the screws (2). See figure 10.

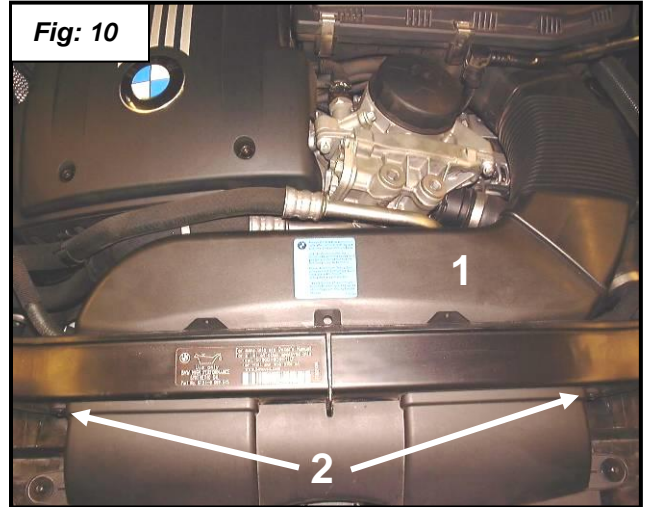

Fig: 10

16. Remove the oil lines (1) from the oil filter control housing by removing the torx bolt marked with an arrow. See figure 11. **Tip:** Use a flex head ratchet and you don't have to remove the fan cowl.

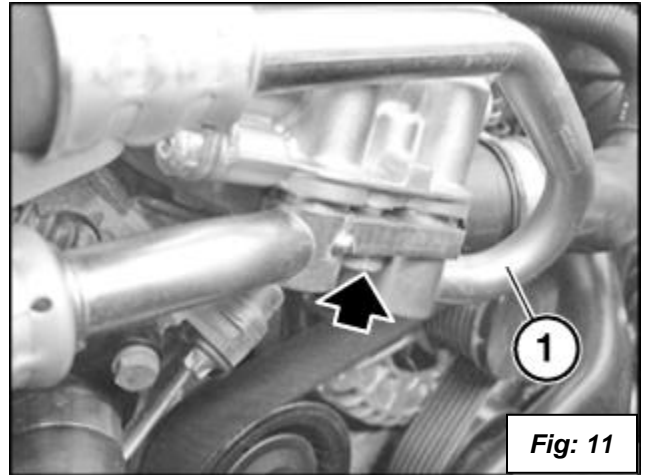

Fig: 11

17. Remove the brake duct by removing the mounting screw. See figure 12.

- 18.

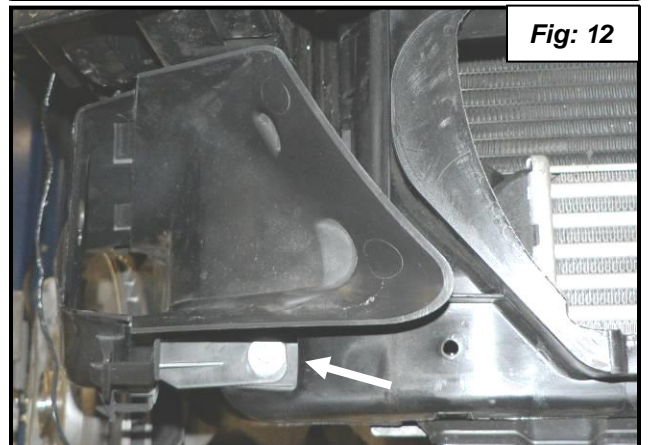

Fig: 12

18. Modify the brake duct as shown in figures 13 and 14.

Fig: 13

Draw a straight line between 1/4" mark and radius 3.5" from edge. Cut on

Measure 1/4" from seam on top and bottom.

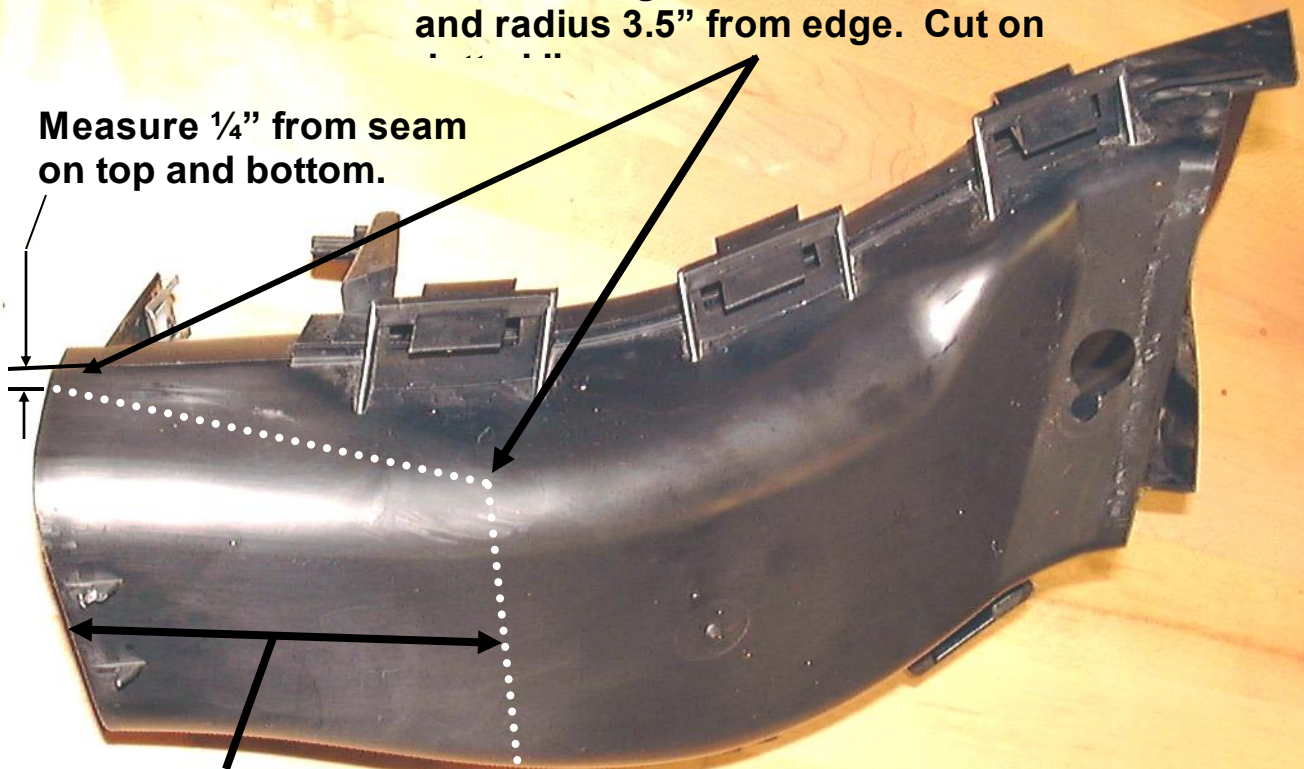

Measure 3.5" out from edge and wrap around radius.

Fig: 14

Finished part with edges filed smooth.

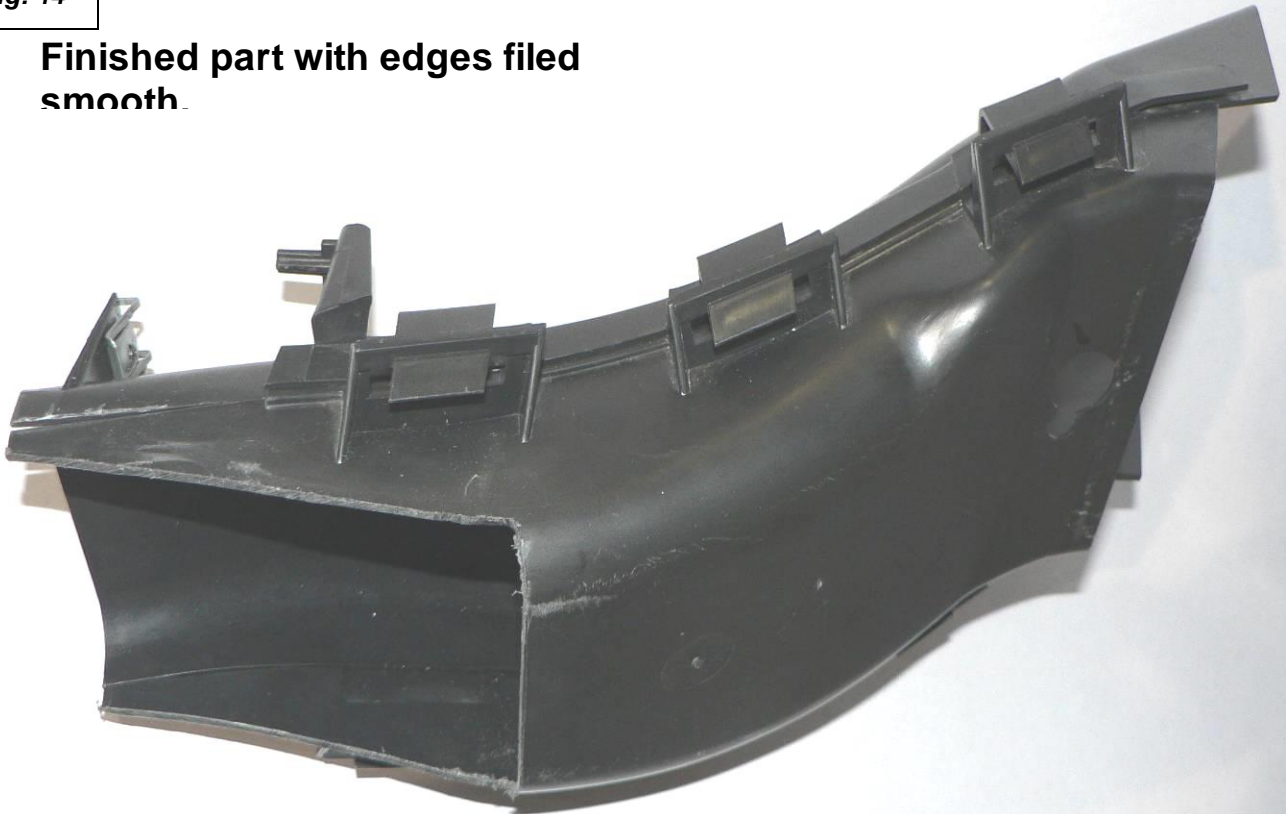

19. Cut off part of the plastic mount that is not needed. You will need the space for clearance the oil cooler. See figures 15 and 16.

- 20.

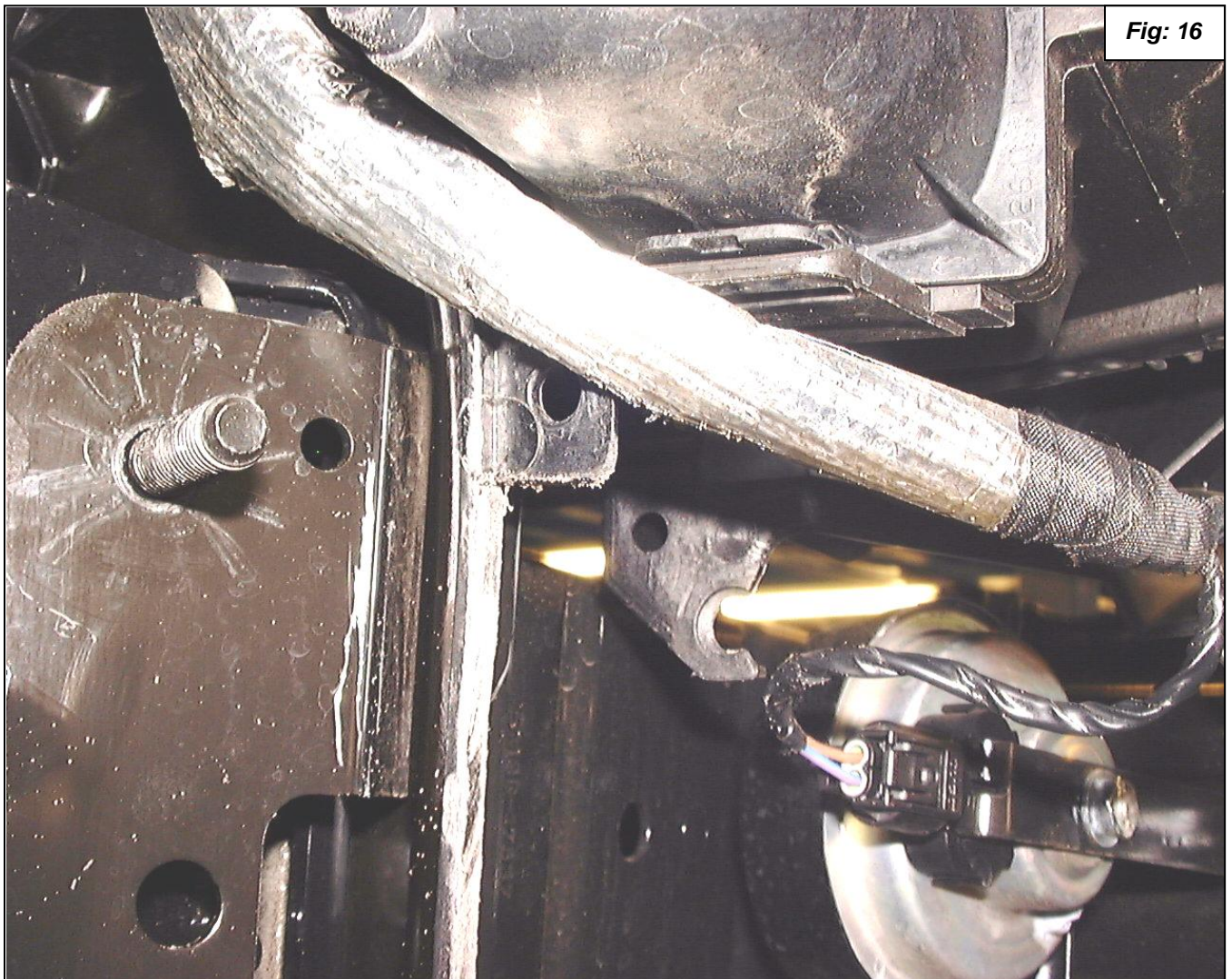
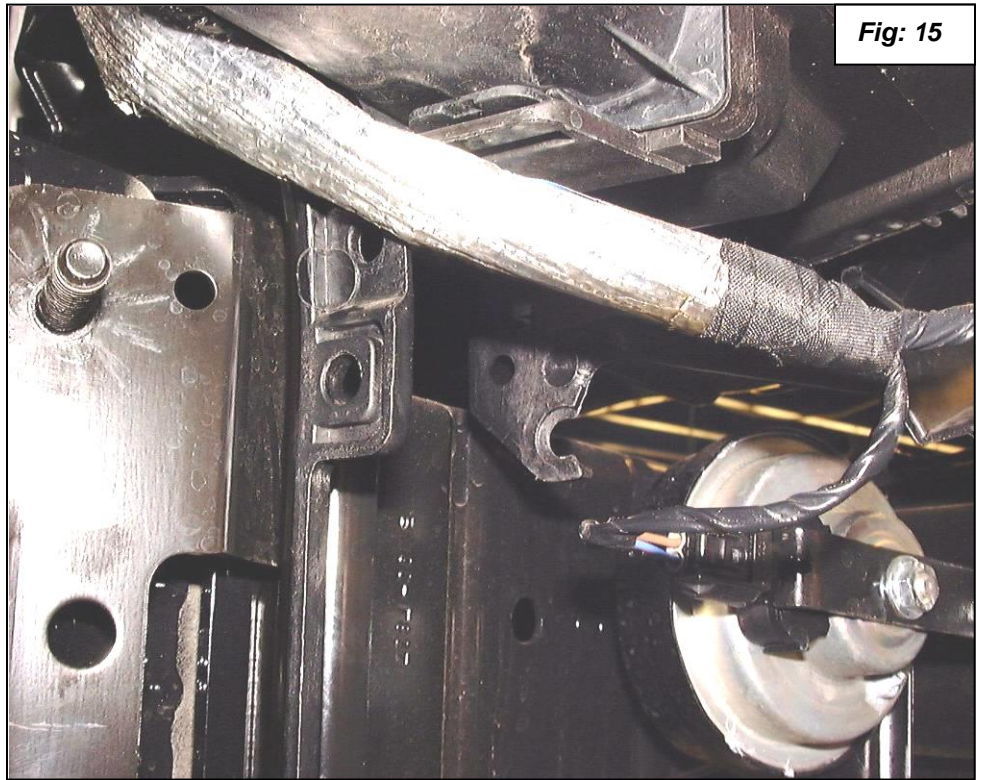

20. You will need to relocate the transmitter for the tire pressure sensing system. The wires that go to it need to be rerouted. See figure 17.



Fig: 17

21. Remove the tape and plastic tube that covers the wires as shown in figure 18.
- 22.

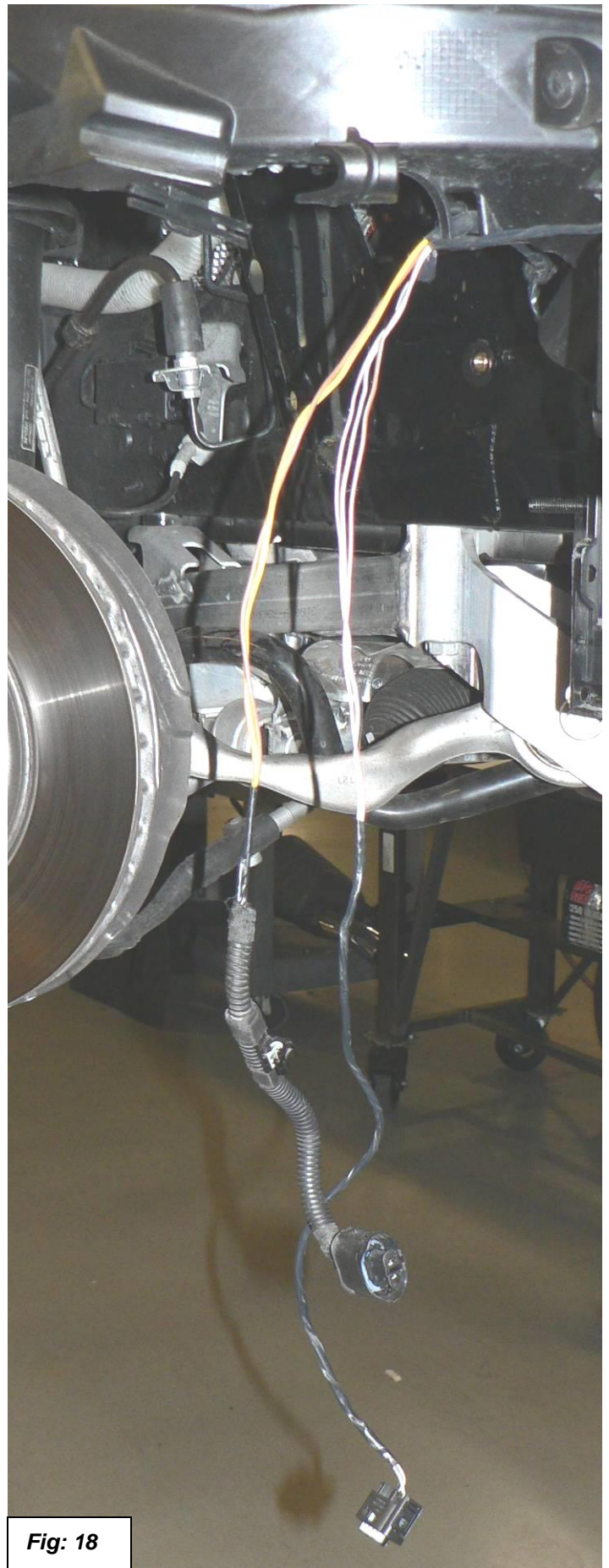
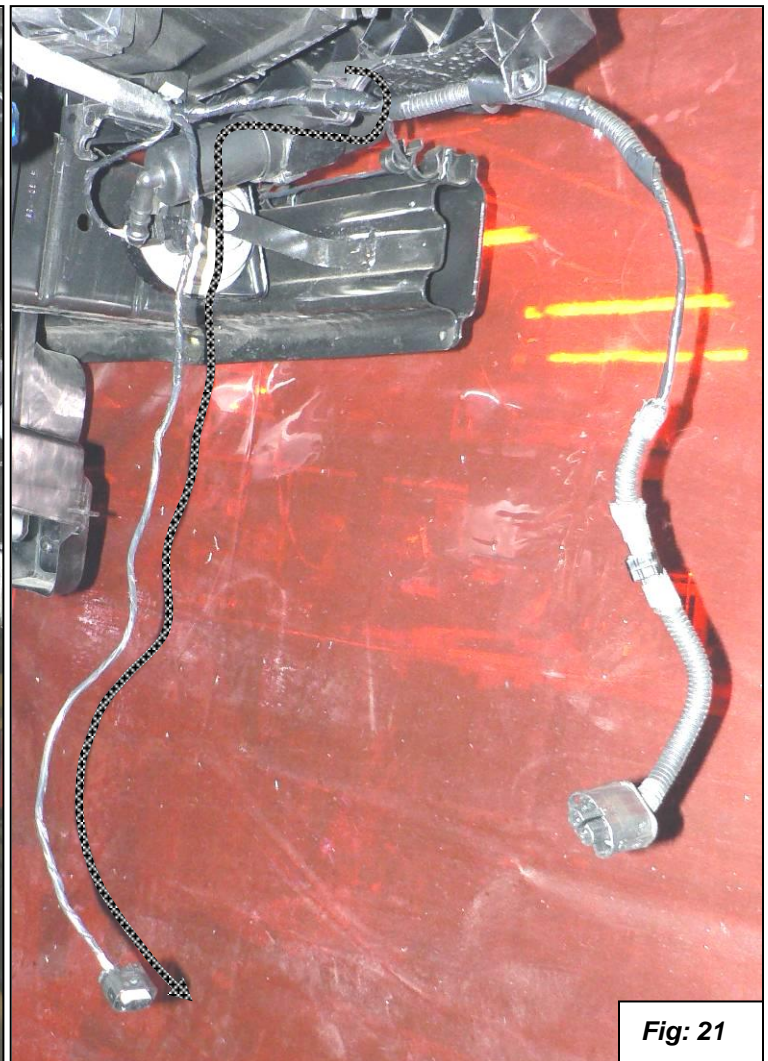
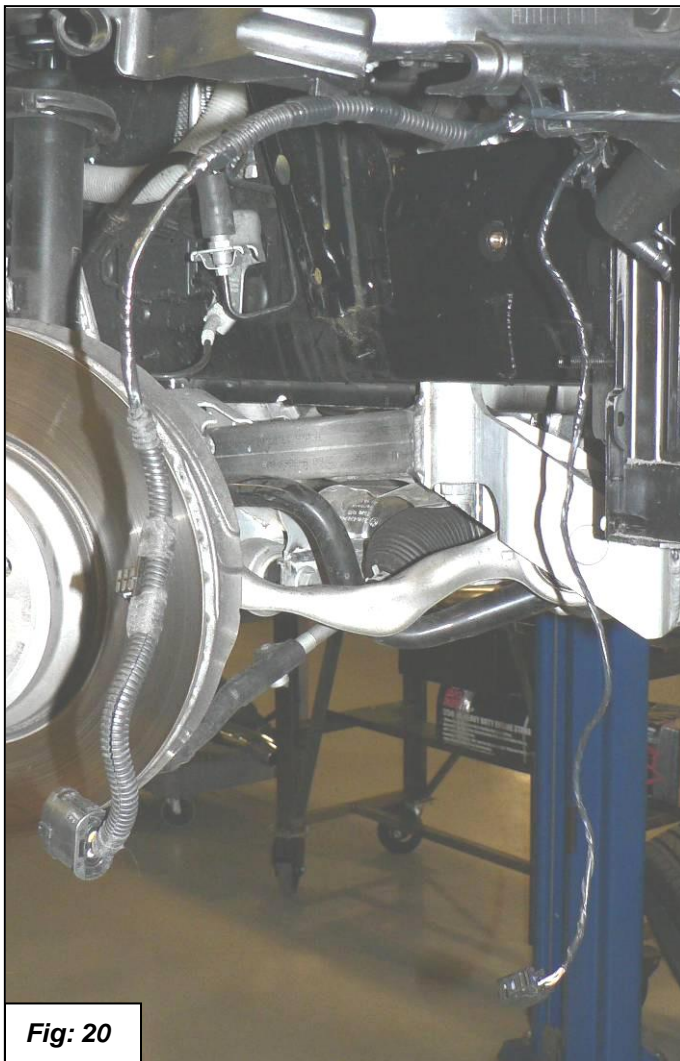
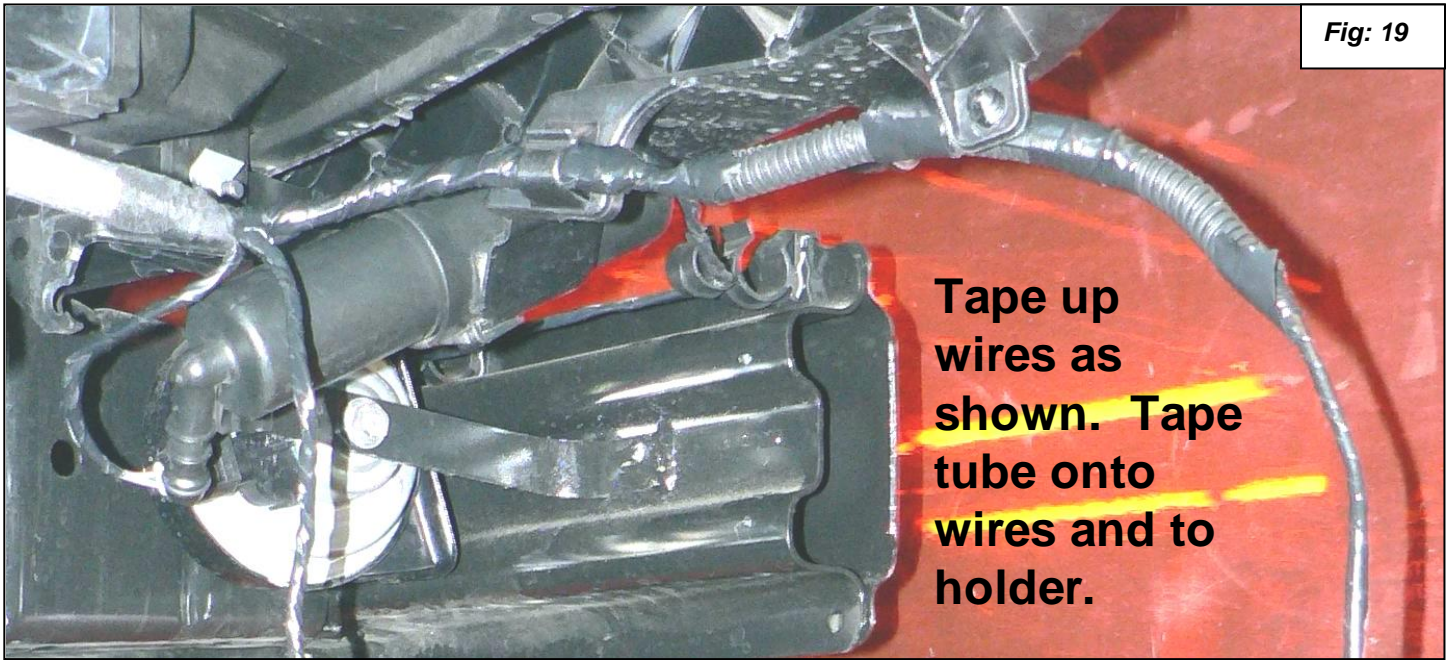

Fig: 18

22. Reroute the wire for the transmitter as shown in figures 19, 20 and 21.



23. Remove the top support bracket from the stock oil cooler. The screws are tamper proof torx. If you do not have the correct tool to remove them, vise grip pliers will work in a pinch. See figure 22.



24. Draw a line on the top support bracket as shown in figure 23. File the point off the bracket for extra clearance for the oil hose as shown in figure 24.



25. Install the top support bracket onto the new Dinan oil cooler mount with the supplied 6mm x 10mm bolts and washers. Install the rubber mounts. See figure 25.



- 26.

26. Install the O-Rings onto the oil line adapter block. Put the 8mm x 25mm Allen head bolt and serrated lock washer in place. See figure 26.

Fig: 26

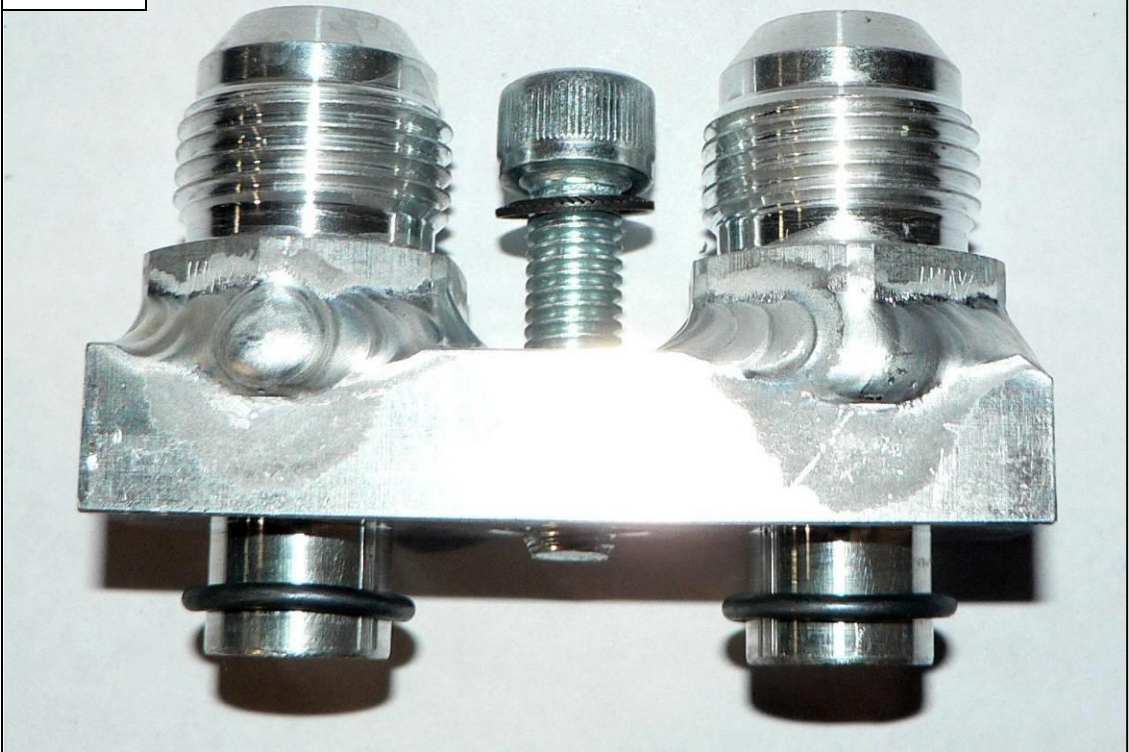

27. Install the oil line adapter block onto the oil filter thermostat housing. Make sure the O-Rings don't get pinched as you install the block. Torque the bolt to 20Nm (15ft-lbs.). See figure 27.

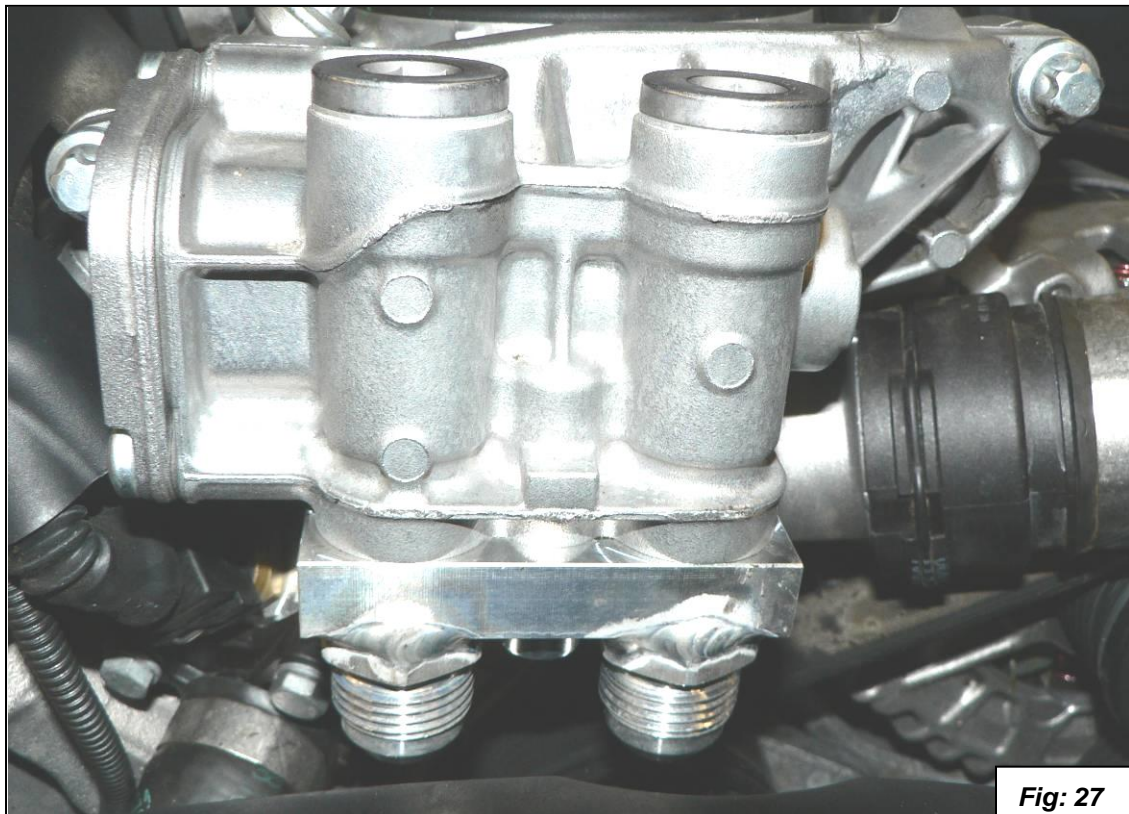

Fig: 27

28. Loosely install the oil line with the 90° fittings on each end. One end has a swivel and one end doesn't. Install the end without the swivel onto the topside of the oil cooler. Do not tighten yet. See figure 28.

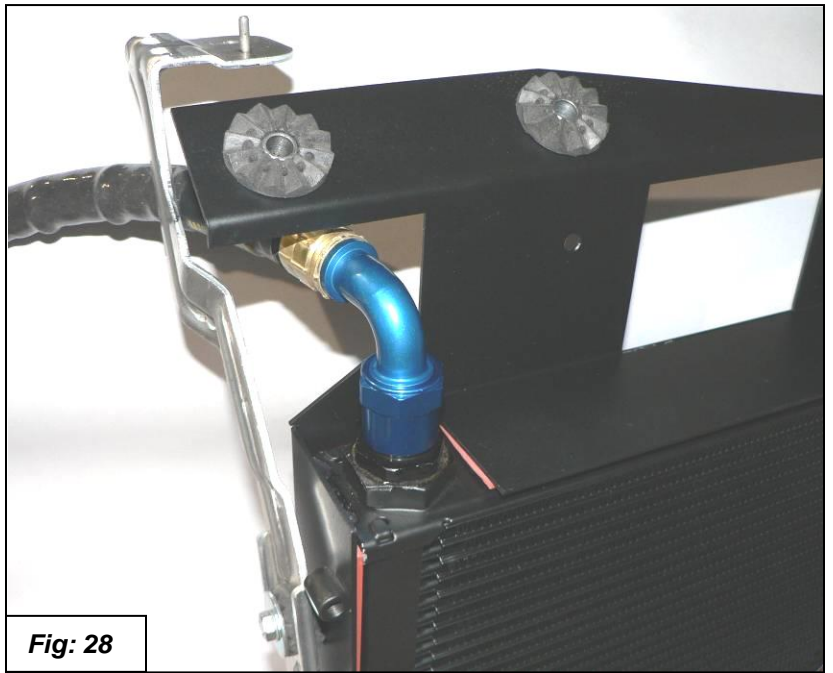

Fig: 28

29. Feed the oil line in between the headlight and the bracket as shown in figure 23. Attach the oil cooler assembly to the mounts as shown with the two stock 8mm nuts and the 6mm bolt. Torque nuts to 20Nm (15ft-lbs.) and bolt to 8Nm (6ft-lbs.). See figure 29.

- 30.

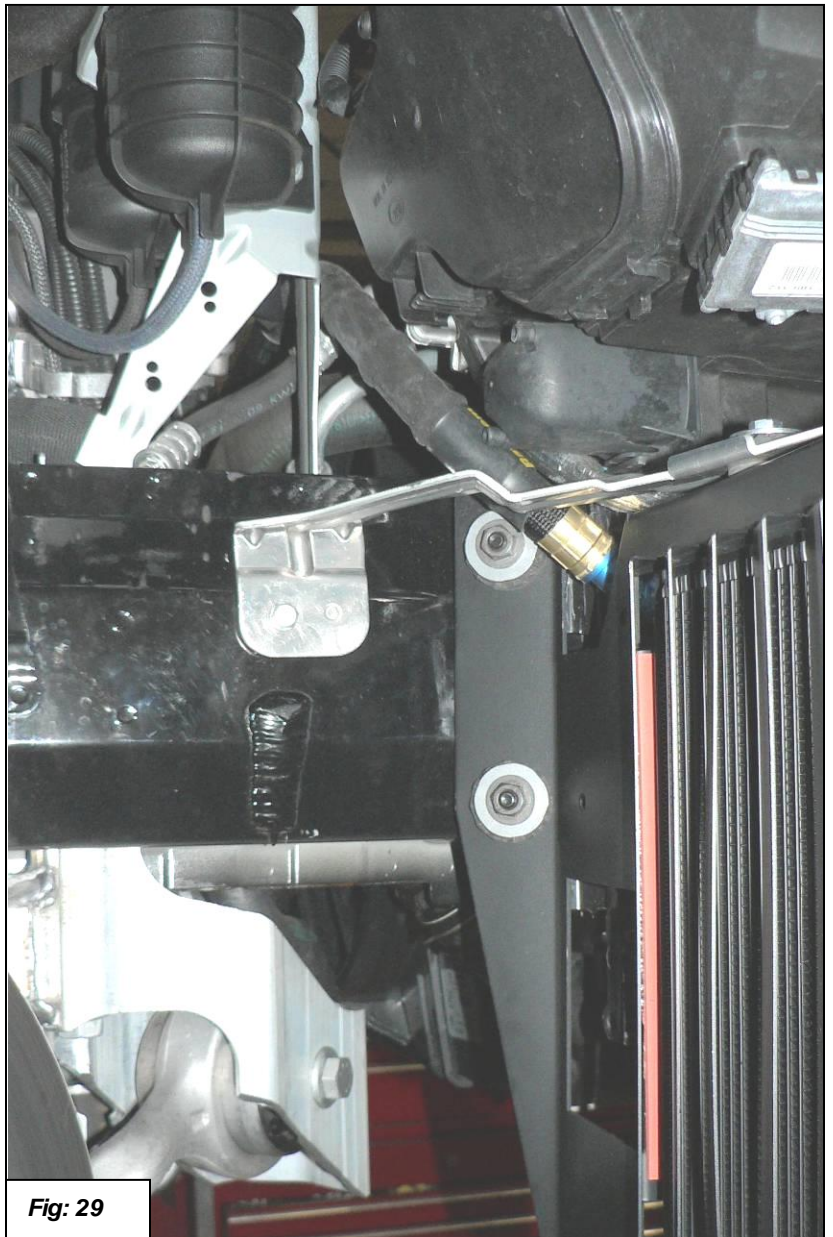

Fig: 29

30. Install the 90° swivel end of oil line onto the adapter as shown in figure 30.



31. The straight end of the lower hose connects to the lower fitting of the oil cooler and the 45° fitting end connects to the adapter block onto the oil filter thermostat housing as shown in figure 31.



32. Check line for best routing and tighten fittings with 2 wrenches, one on hose fitting and the other on fitting attached to oil cooler or adapter block.

33. Install the modified brake duct and check for clearance. With the oil cooler in a relaxed position you should have about 1/2" clearance as shown in figure 32.

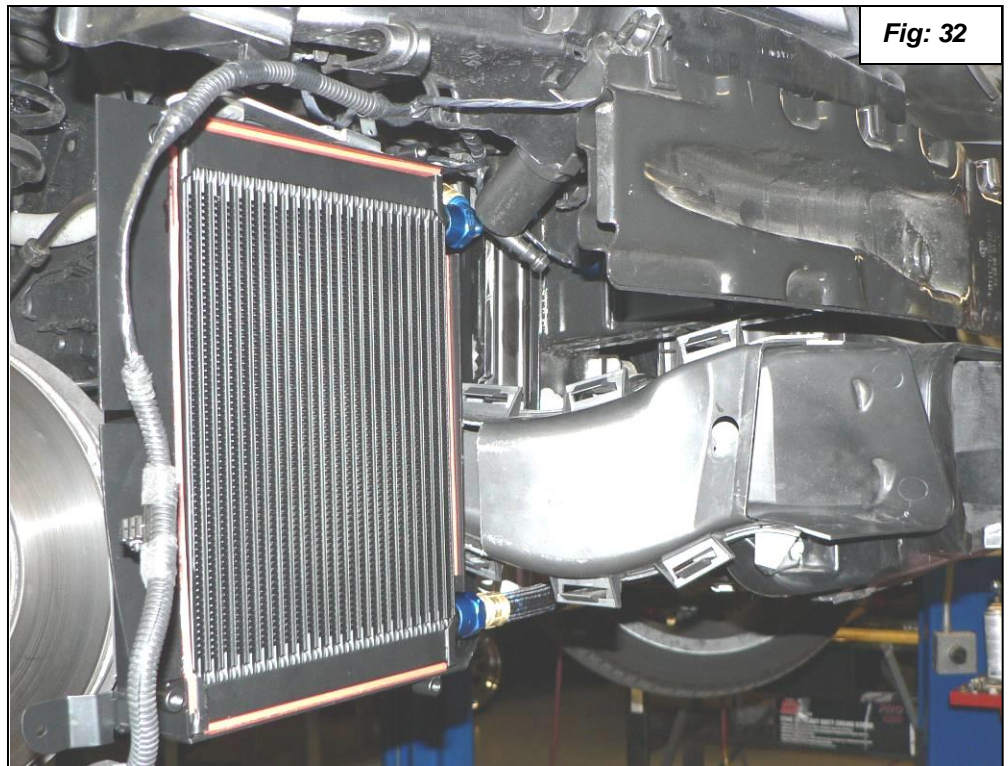

34. When you pull the cooler into the position it will be with the bumper attached the clearance should be flush. See figure 33.

35.

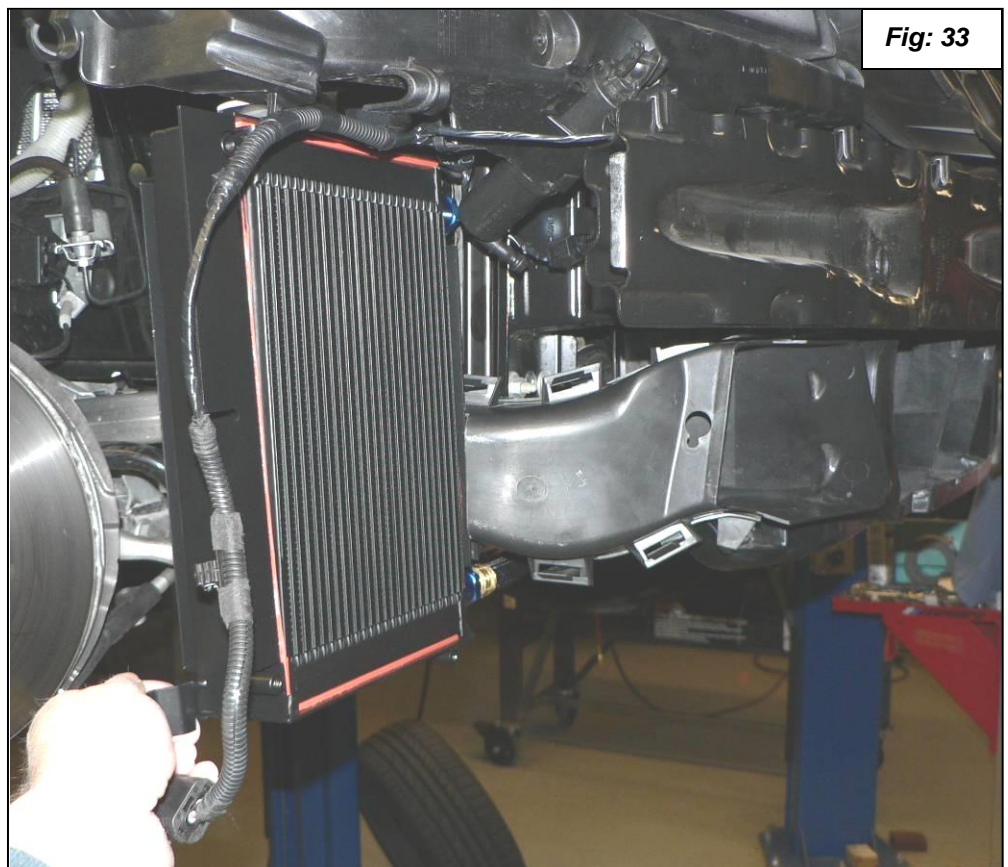

35. Install the air duct onto the oil cooler assembly with the four supplied 6mm x 12mm hex head bolts and wave washers. See figure 34.

36. Pull the upper edge seal back far enough to put the rubber grommet around the wire for the fog light as shown in figure 35.

37. Route the wire for the tire pressure transmitter up and around the headlight flange as shown in figure 36.

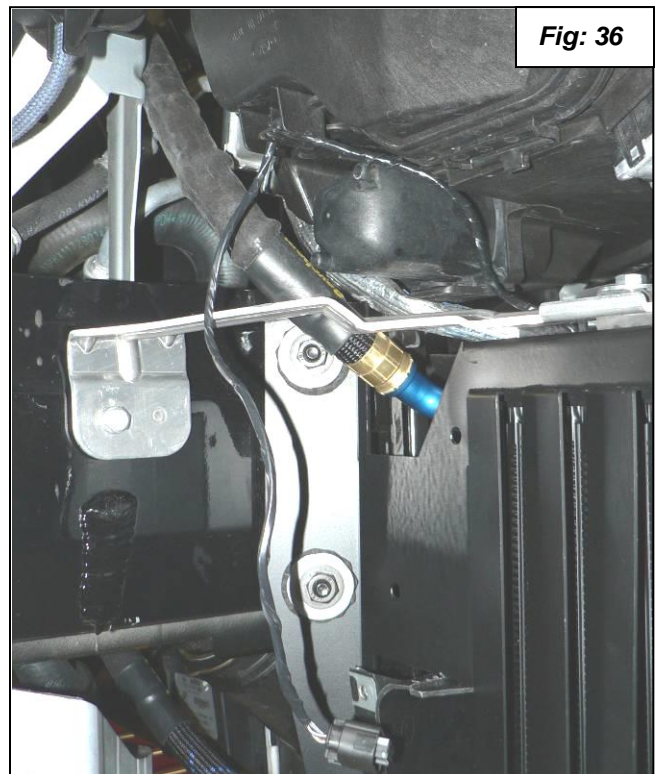
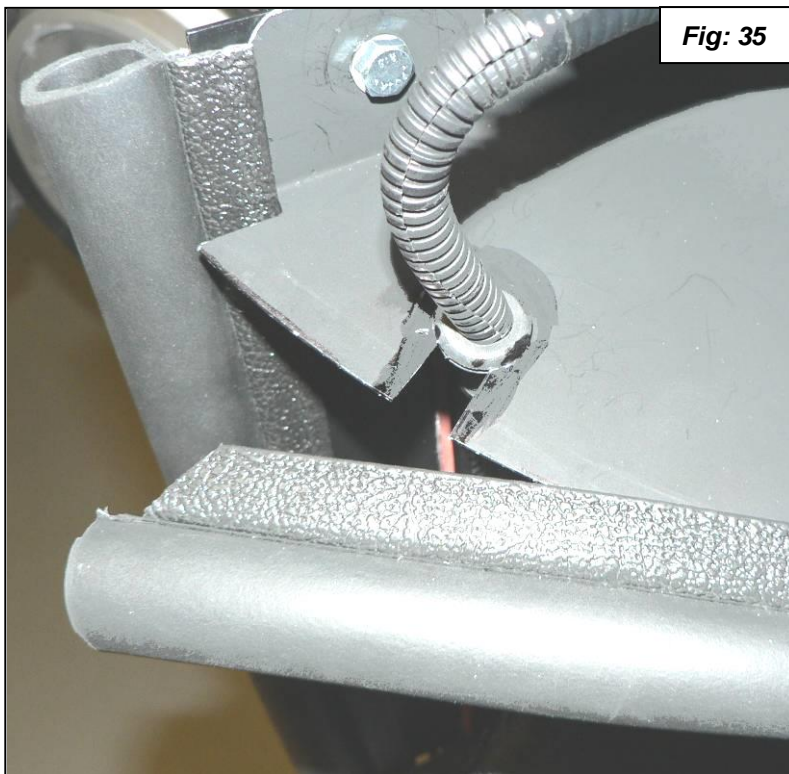
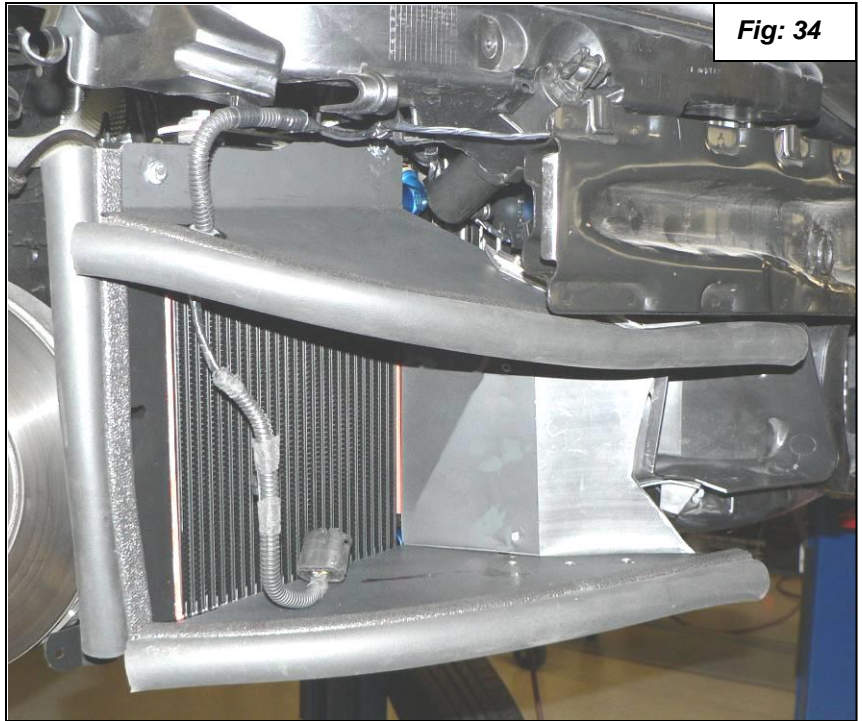

38. Install the bumper over the air duct after connecting the fog light on the passenger side as you install it.

39. Fasten the top screws (1) as shown in figure 37 and the side screws (2) as shown in figure 38.

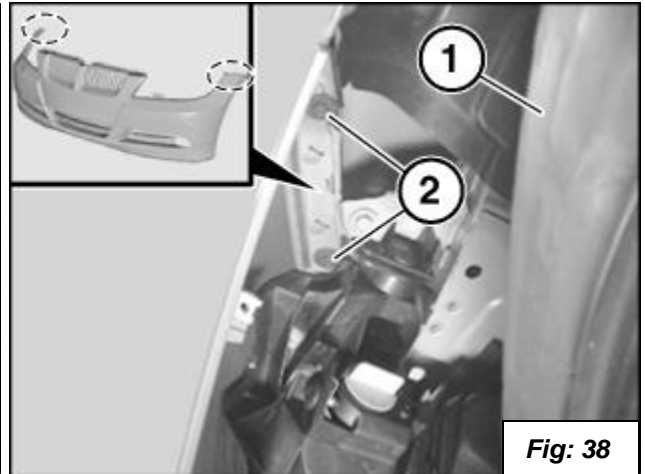
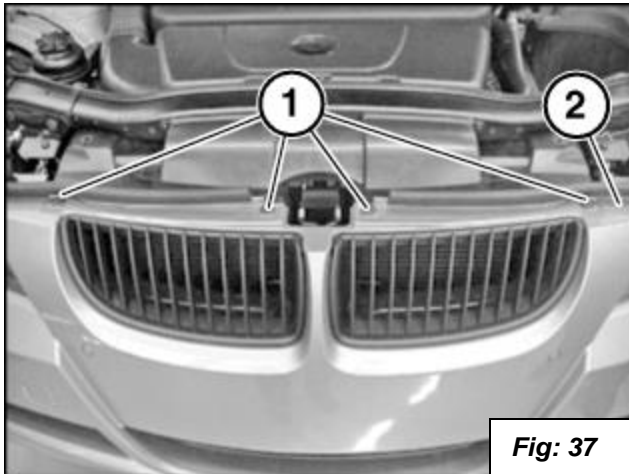

40. Fit the inner fender into position and mark as shown in figure 39 so you can enlarge the opening for the oil cooler vent.

41. Remove inner fender and cut as marked.

- 42.

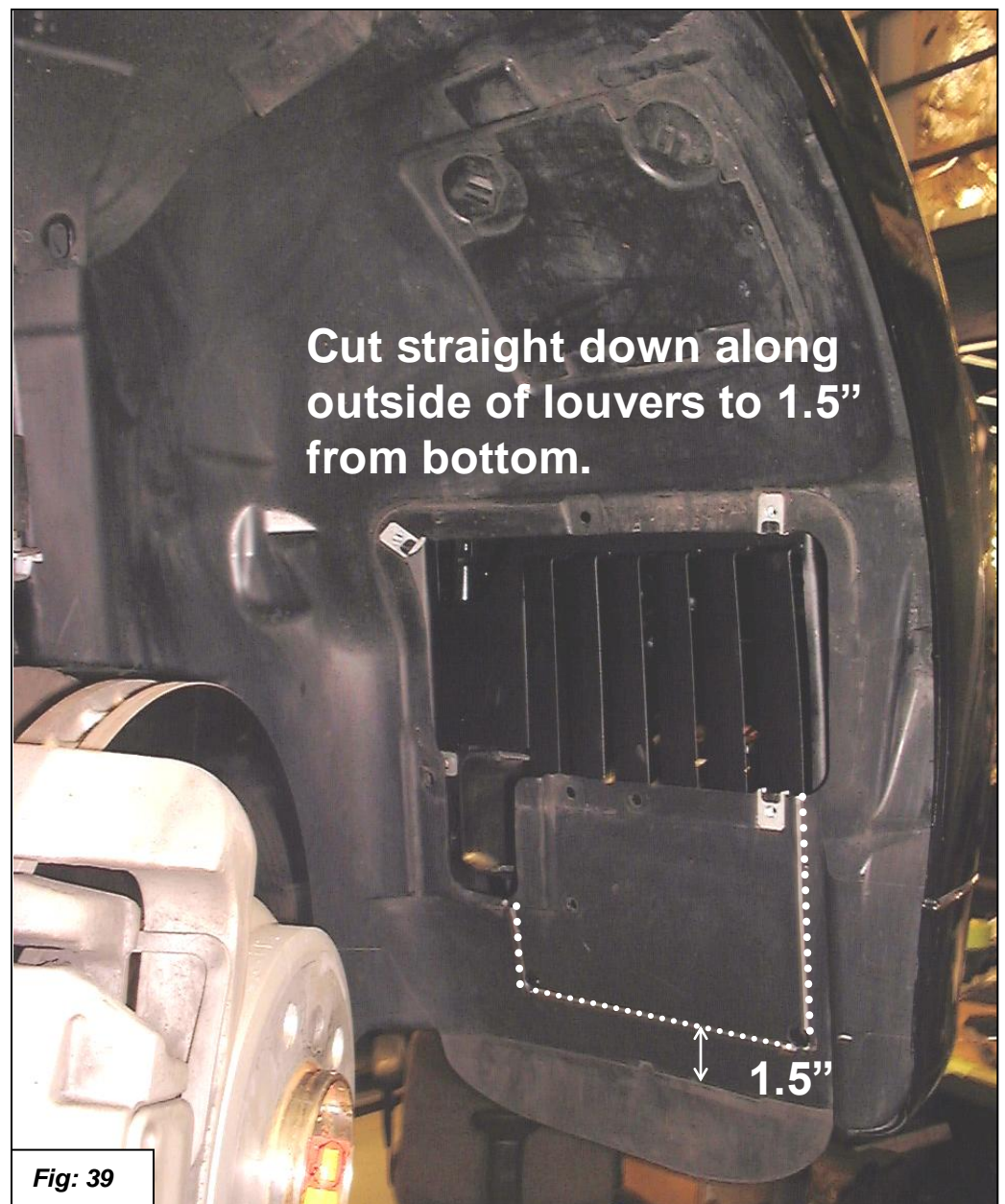

42. Trim the inside of the inner fender as shown in figures 40 and 41.

Fig: 40



Fig: 41



43. Lay the tire pressure transmitter about $\frac{3}{8}$ " to $\frac{1}{2}$ " away from the side of the headlight cut out inline with the top. See figure 42. Make sure connector is pointing down. Mark the holes and drill out to 7mm. Attach transmitter with stock push rivets.



44. Cut the stock louvers as shown in figures 43 and 44.

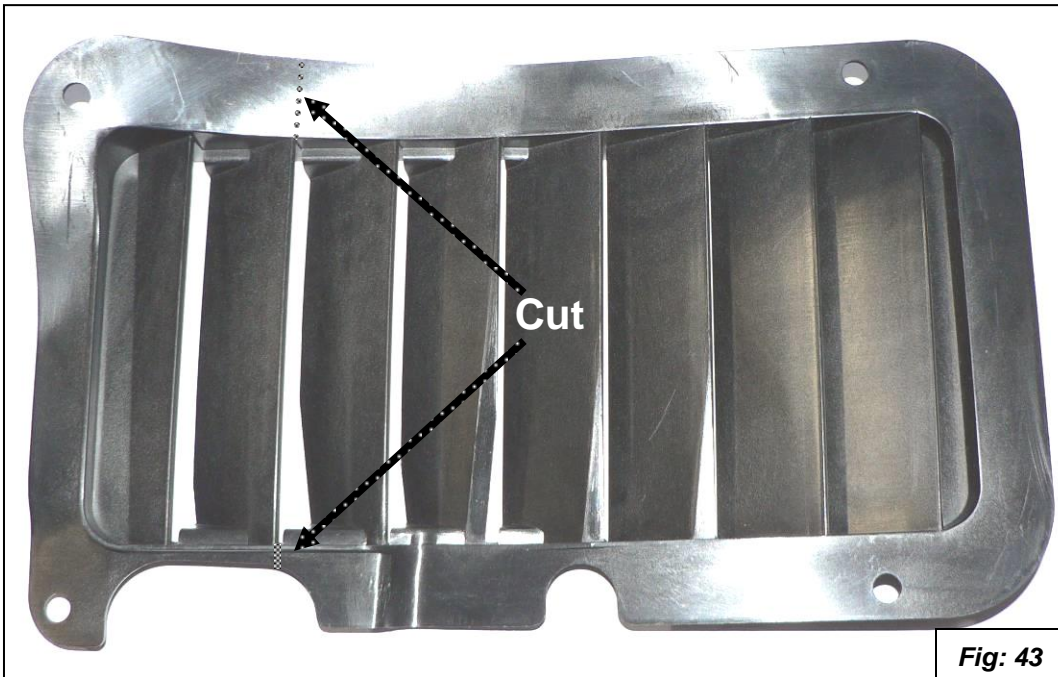

Fig: 43



Fig: 44

45. Install the inner fender while connecting the tire pressure transmitter. Install the modified louvers. See figure 45.

46. Install the other inner fender and bumper screws that you removed in the first steps.

47. Install the right front wheel and torque to 120Nm (89 ft-lbs.).

48. Outside or in a well ventilated area, bring engine up to operating temperature. Run the engine at a constant speed of 3500rpm until the oil thermostat opens and the oil level low warning comes on. Let engine back to idle then shut engine off. Add 1 quart of appropriate oil to engine.

Enjoy.



Fig: 45

PARTS LIST

<u>Qty</u>	<u>Part No.</u>	<u>Description</u>
1	D573-0031	Oil Cooler
1	D573-0002	E90 Duct Assembly
1	D573-0044	Oil Line Mount
1	D573-0036	Hardware Kit
	Contains:	
6		M6 Wave Washer
2		M6 x 10 Bolt
4		M6 x 12 Bolt
2		M6 x 25 Washer
1		M8 Ribbed Washer
1		M8 x 25 Allen