

PAPER • OPEN ACCESS

Flow studies on increasing the efficiency of the inlet manifold

To cite this article: D Moldovanu *et al* 2019 *IOP Conf. Ser.: Mater. Sci. Eng.* **568** 012050

View the [article online](#) for updates and enhancements.

You may also like

- [Analysis of Sediment Distribution at the Intake Structure](#)
B Bakri, S Pallu, R Lopa et al.
- [Temperature-dependence of the single-cell variability in the kinetics of transcription activation in *Escherichia coli*](#)
Nadia S M Goncalves, Sofia Startceva, Cristina S D Palma et al.
- [Investigation on the roll-to-plate imprinting of metallic surface micro dimples](#)
Zhaoyang Gao, Hui Zhang and Yufeng Wen



The Electrochemical Society
Advancing solid state & electrochemical science & technology

242nd ECS Meeting

Oct 9 – 13, 2022 • Atlanta, GA, US

Abstract submission deadline: **April 8, 2022**

Connect. Engage. Champion. Empower. Accelerate.

MOVE SCIENCE FORWARD



Submit your abstract



Flow studies on increasing the efficiency of the inlet manifold

D Moldovanu^{1*}, A Csato¹, N Bagameri¹

¹Technical University of Cluj-Napoca, Automotive Engineering and Transports
Department, Bd. Muncii 103-105, Cluj-Napoca, Romania

dan.moldovanu@auto.utcluj.ro

Abstract. The current study focuses on improving the flow of air through the inlet manifold. With using CFD software, the phenomena occurring within the pipeline are studied. Modification of the intake results in an increase in the air mass flow, and thus in the increase of the engine performance. The air flow rate allowed at the boundary layer between the duct and the air tends to be zero. The high-rugged surface increases the flow velocity in the center of the tube. In this paper, the effect of a rough surface created by dimples in the intake pipe is studied. By applying small dimples to the surface of the piping, the velocity distribution becomes more uniform within the tube. Dimples cause lowering pressure at the start, thus increasing the air flow rate. The limit layer that has low flow rates relative to the speed at the center of the tube becomes thinner. By applying this method, the air flow rate in the intake manifold can be improved.

1. Introduction

In the automobile industry continuous research on the flows around bluff bodies and “immersed bodies. With a better understanding of the fluid dynamics can lead to an improvement in the design. Examining solutions from the past can provide new ideas, like the solution used in case of a golf ball where a small change in the surface geometry results in a significant change in drag. The dimples lead to a turbulent flow which is similar to adding roughness to the surface. Studying dimples may help to improve the air intake system on the internal combustion engine.

2. Inlet manifold

In the following paragraph short description of the flow in the intake manifold is presented, it is one of the central parts of the engine. The role of the intake manifold is to provide a uniformly distributed air flow to the cylinders, rational design can reduce the inlet pressure losses also increasing the air volume introduced in engine. Increasing the inlet manifold efficiency is a major challenge to increase the engine overall efficiency, in this way the emissions can be reduced. Volumetric efficiency of the engine is a measure of the effectiveness of the air intake system composed by intake manifold, intake port and cylinder [1]. This means that the velocity of air in the inlet manifold is increasing more air the intake system can deliver to the engine. This will increase the volumetric efficiency, this effect can increase the torque and the power of the engine [2]. Many studies are related to the shape and length of the inlet manifold [3]. On the effect of the boundary layer which is being generated by air flow through the inlet manifold there are only a few studies [4]. Computational Fluid Dynamics (CFD) is a helpful tool for predicting the flow characteristics in the inlet manifold.

Using dimples on the surface: Adding dimples to a surface is similar to adding roughness to the surface, the effect of the boundary layer has to be similar to the flow over a rough surface. On the



boundary layer in dimples are vortices created like in Figure 1. Flow over the dimpled surface can generate stable vortices.

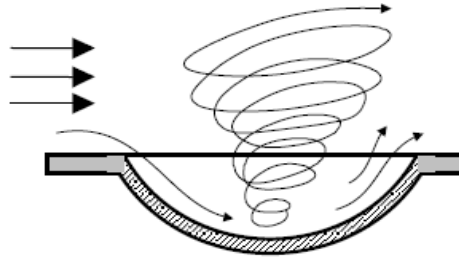

Figure 1. Mechanism of swirl motion in a dimple [5].

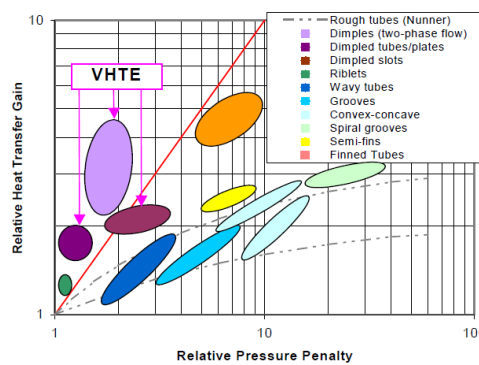

Figure 2. Effectiveness of different skin roughness technics [5].

The red line represents linear dependencies between heat transfer and pressure drop properties of surface roughness achieved with different techniques. Figure 2 shows that VHTe (vortex heat transfer enhancement) provide the best heat transfer with the least pressure drop then every other technique. Simulating the flow over golf ball shows that dimples create vortices on the surface, these vortices are increasing the momentum near the wall and serve to reattach the flow after the dimple[6]. Simulations prove that flow over a dimpled flat surface achieve higher velocity due to the fact they are creating a favorable pressure gradient [7]. This publication is focusing on using dimple technology in inlet manifold for achieving higher volumetric efficiency.

3. Simulation data

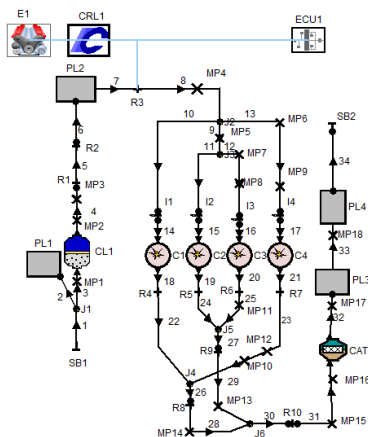

Figure 3. AVL Boost engine model for input data.

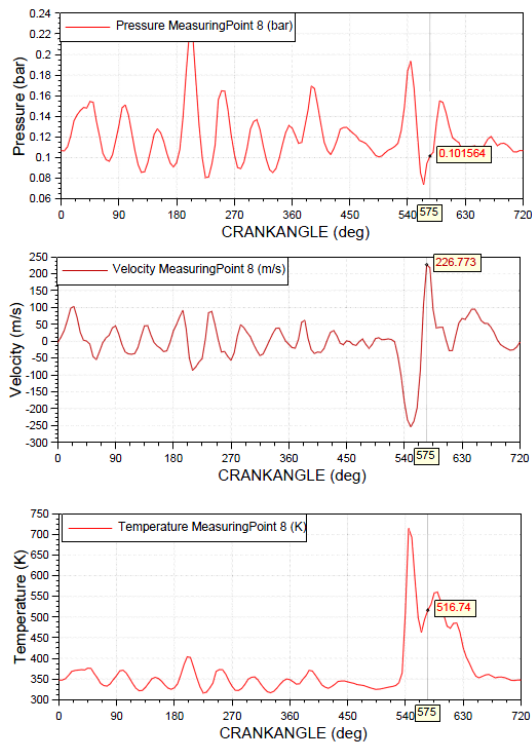

Figure 4. Results in inlet manifold measuring point at 2000 rpm.

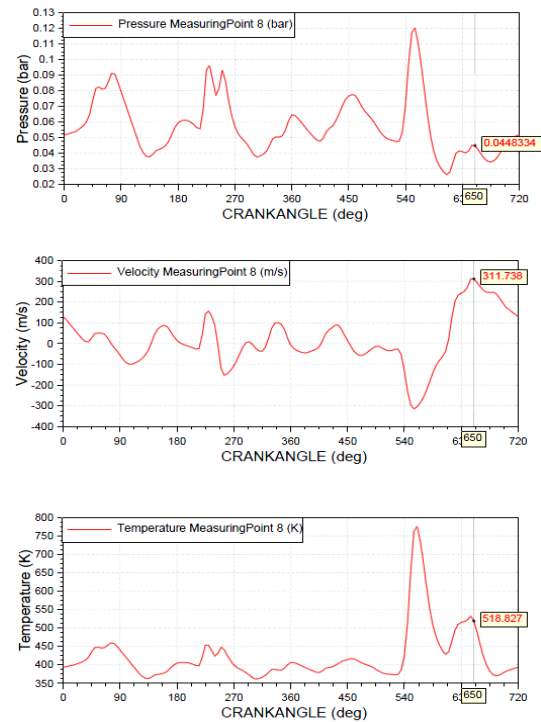

Figure 5. Results in inlet manifold measuring point at 6000 rpm.

Correct input data for CFD simulation is one of the most important requirement to have valuable results, just like seen in other researchers [10]. For having input data for simulation of inlet manifold pipes a one cylinder engine model (Figure 3) is used, the simulations are performed in AVL Boost. The load of the engine is controlled by the ECU via R3 flow restriction on the inlet system. Two different cases is taken into consideration one on 2000 rpm and one on 6000 rpm. The engine parameters are shown in Table 1 as input data for CFD simulation the air velocity and temperature in MP8 measuring point are taken in count.

Table 1. Simulated engine characteristics.

| | Data | Unit |
|------------------|-------------|------|
| Bore | 86 | [mm] |
| Stroke | 86 | [mm] |
| Nr. of cylinders | 4 | [-] |
| Injection type | Indirect | |
| Control | Intake flap | |

4. Simulation scheme

For accurate results the inlet will be in plenum before the pipe system to cover the turbulence generation then the flow is introduced in the smooth surface pipe, the entry pipe length is for developing the flow to have a fully developed velocity profile that is not changing with the length of the pipe. For the calculation of the entry pipe length Reynolds number is taken into the consideration and the equation **Error! Reference source not found.** is used, where l_1 is the entry length, D is the diameter of the pipe and Re_c is the Reynolds number. The equation **Error! Reference source not found.** is only available for turbulent flow:

$$\frac{l_1}{D} = 4.4R_e^{1/6} \quad (1)$$

Since velocities higher than 120m/s were used, the Reynolds number is over 4000 so the flow is turbulent[8].

After the entry pipe a 200 mm length dimpled pipe with the same diameter is used. Before the outlet boundary condition another smooth surface pipe with the same length as the first one is used to getting a fully developed flow at the outlet. The simulated system scheme is in Figure 6.

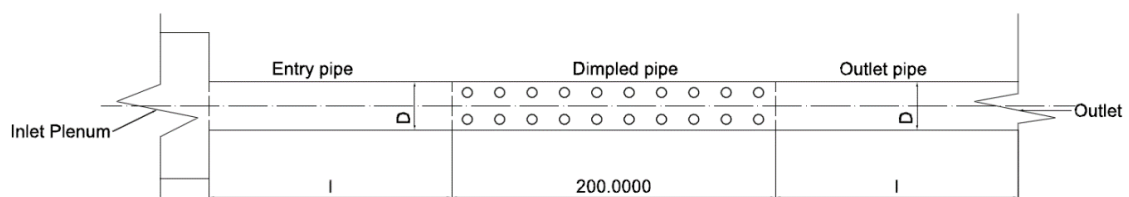

Figure 6. The analyzed pipe system scheme.

Dimples analysis: in this section different forms of dimples are studied. The flow over dimples is governed by the vortices created in dimples. As the pressure is minimum in the center of the vortex [9] this phenomenon creates a reattaching flow after the dimple. Either laminar or turbulent flow they are affected by boundary layers. The shear stress created by the boundary layer has a different magnitude for laminar and turbulent flows. Due the upward eddy motion of the fluid particles has a negative effect on the velocity of the flow, this momentum transfer from the lower part of the flow to the upper part reduces the velocity of the lower part. The force is acting on the particle that is moving through differential area dA **Error! Reference source not found.** it depends on the horizontal (u'), vertical (v') velocity and also on density (ρ). Creating vortices with dimples with reduces the vertical velocity of the particle, thereby the negative effect of this phenomenon on the velocity is decreased.

In this section five different shapes for dimples will be studied. For having accurate results for different dimples forms only one dimple is simulated with a simulation scheme in Figure 7. The best shape of the dimple is chosen the pressure distribution in the upstream of the dimple and also the flow reattaching length. Having lower pressure inside the vortices created by dimples and smaller reattaching length makes the dimple shape more effective.

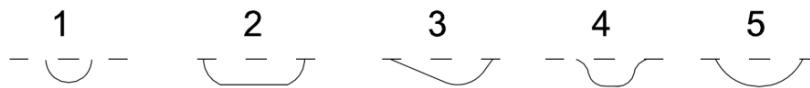

Figure 7. Studied dimples shapes.

Based on the results shape nr1 which is a half globe creates the smallest flow reattaching length and creates the highest vortex, therefore it was considered for further investigations/simulations. The inlet was populated with shape 1 dimples so that the air flow can be analyzed.

5. Simulation with shape nr. 1

Shape nr. 1 has the smallest reattaching length and maximal kinetic energy. Shape nr. 1 is a half globe which is a perfect shape for creating vortices.

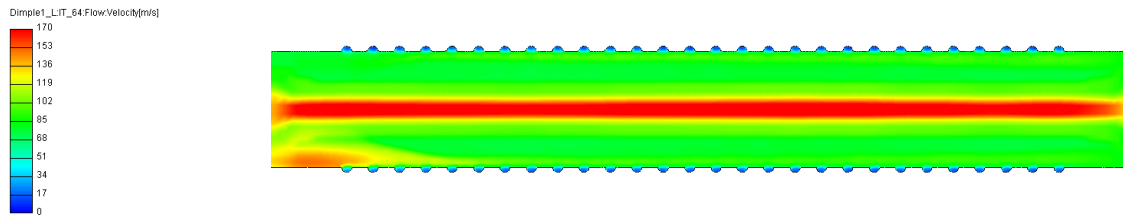

Figure 8. Air velocity with nr. 1 shape [m/s].

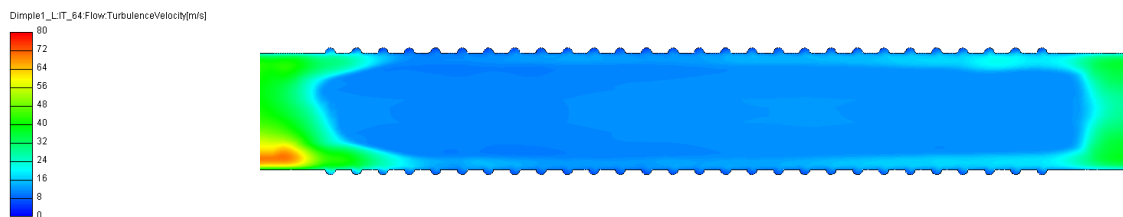

Figure 9. Turbulence velocity [m/s].

6. Conclusions

Figure 8 represents the air flow velocity on a dimpled intake tube with the length of 200 mm, after the flow is entering in the dimpled is shaped into a straight vane having a stable high-speed flow in the middle of the tube. The flow in the center of the tube has a 39.5% higher speed than at the inlet speed. The stabilization effect of the dimples creates a constant turbulence velocity (Figure 9) in the dimpled section. The density of the dimples and placement will be further analyzed including the simulations for bent intake pipes.

References

- [1] Nicolao, G. De, Scattolini, R., Siviero, C., ‘Modelling the volumetric efficiency of ic engines: Parametric, non-parametric and neural techniques’, *Control Eng. Pract.*, vol. 4, no. 10, pp. 1405–1415, 1996.
- [2] Ganesan, V., *Internal Combustion Engines*, 2nd edn. Singap: Tata McGraw-Hill Publishing Company Limited, 2004.
- [3] Bayas, J., Wankar, A., Jadhav, N., ‘A REVIEW PAPER ON EFFECT OF INTAKE MANIFOLD GEOMETRY ON PERFORMANCE OF IC ENGINE’, 2016.
- [4] Pahmi, M. A. A. H., Che Mat, S., Nasruddin, A. N., Ismail, M. F., Yusof, M. N., ‘The Analysis of Intake Manifold Air Stream Velocity on Different Material Roughness’, in *Applied Solutions of Engineering Science*, 2014, vol. 661, pp. 143–147.
- [5] Chudnovsky, Y., Kozlov, A., ‘Development and Field Trial of Dimpled-Tube Technology for Chemical Industry Process Heaters’, 2006.
- [6] Smith, C. E., Beratlis, N., Balaras, E., Squires, K., Tsunoda, M., ‘Numerical investigation of the flow over a golf ball in the subcritical and supercritical regimes’, *Int. J. Heat Fluid Flow*, vol. 31, no. 3, pp. 262–273, 2010.
- [7] Michael Mode, J., ‘Simulation of the Flow Over a Flat Dimpled Plate’, 2010.
- [8] Schobeiri, M., *Fluid mechanics for engineers. A graduate textbook*. 2010.
- [9] Jeong, J., Hussain, F., ‘Hussain, F.: On the identification of a vortex. JFM 285, 69-94’, *J. Fluid Mech.*, vol. 285, pp. 69–94, 1995.
- [10] Chioreanu N, Mitran T, Rus A and Beles H 2014 *Numerical simulation of thermal-hydraulic generators running in a single regime*. Central European Journal of Engineering, Volume 4, Issue 2, June 2014, Pages: 119-124. Publisher: Springer-Verlag Wien, DOI: 10.2478/s13531-013-0145-2, ISSN: 18961541t